

# nKeyer

*A Flexible Arduino Nano-based Amateur Radio  
Keyer Project from N7XG*

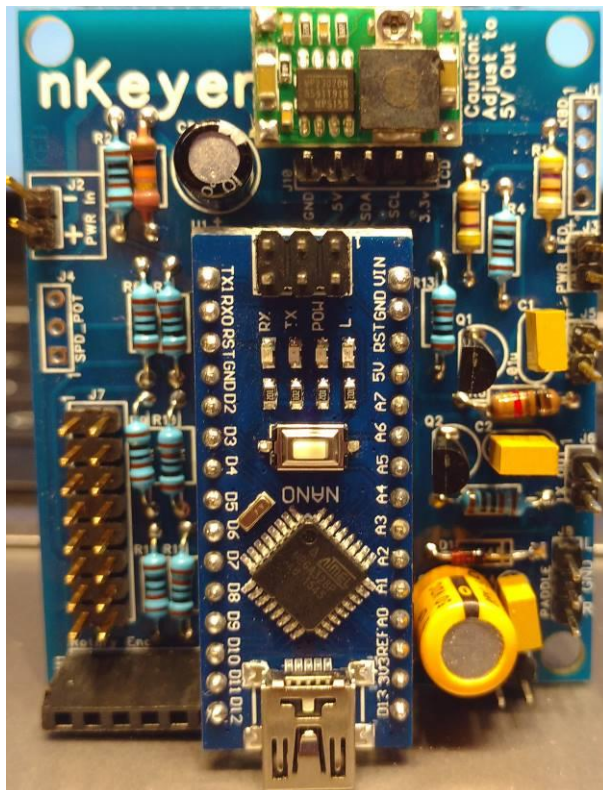

N7XG, Salem, Oregon 97302  
© 2011-2016 N7XG All rights reserved.  
Published 2016  
Printed in United States

N7XG ("Developer") has made every effort to ensure the accuracy of this document. Developer makes no warranties with respect to this documentation and disclaims any implied warranties of merchantability and fitness for a particular purpose. The information in this document is subject to change without notice. Developer assumes no responsibility for any errors that may appear in this document.

The information contained herein is the exclusive and confidential property of N7XG, except as otherwise indicated.

We wish to also thank the Do It Yourself Community for the inspiration it has given us in the development of this product.

All other trademarks acknowledged.

# Table of Contents

- 1. OVERVIEW OF THE NKEYER.....3**
- 1.1 SCHEMATIC .....4
- 2. ASSEMBLY INSTRUCTIONS.....5**
- 2.1 NKEYER BOARD BOM/PARTS LIST.....5
- 2.2 OTHER PARTS TO CONSIDER.....6
- 2.3 NKEYER PARTS ASSEMBLY .....7
- 2.3.1 *First Things First*.....7
- 2.4 ASSEMBLY GUIDE .....8
- 2.4.1 *Install Parts*.....8
- 2.4.2 *Setting the BUCK*..... 12
- 2.4.3 *Installation final assembly* ..... 12
- 2.5 PROGRAMMING..... 12
- 2.6 TEST..... 13
- 3. CONNECTORS / OPTIONS..... 14**

# 1. Overview of the nKeyer

This documentation covers the construction of the nKeyer board and general use. It approaches this task as a learning exercise for new builders, so that they can develop proficiency and self-confidence. The project itself is quite simple and if you follow the steps you will have a working board able to use for armature radio.

The nKeyer is a simple Arduino based device designed to act at its basic level, as a stand-alone “electronic keyer” with a Morse code paddle. Flexibility has been built in providing additional features such as:

- Based on the Open Hardware K3NG Nano Keyer hardware.
- Uses the K3NG Arduino open-source firmware here: [https://github.com/k3ng/k3ng\\_cw\\_keyer](https://github.com/k3ng/k3ng_cw_keyer) . Also see: <https://nanokeyer.files.wordpress.com/2012/01/nanokeyer-firmware-upload-guide-21.pdf> for details on using and programming the code.
- Compatible with the Nano Keyer Rev D open hardware design.
- USB interface for programing AND keyer control.
- Winkey compatible
- Output to drive a transmitter if desired.
- Can be used with or without a 1602 SPI text display.
- Provides 8 pushbutton inputs for providing canned Morse coded messages.
- Provides an optional keyboard interface for command line control if desired.
- Additional optional features that make it useful as a CW Contest Keyer Addon.
- 5V powered, or OPTIONALLY can be powered from a 7- 23 volt input through a small onboard “buck converter” that is adjusted to 5v output (details later in this guide).
- Power and Transmit LED indicators.
- Morse speed is adjustable, on the fly, from a rotary encoder or simple potentiometer (your choice)



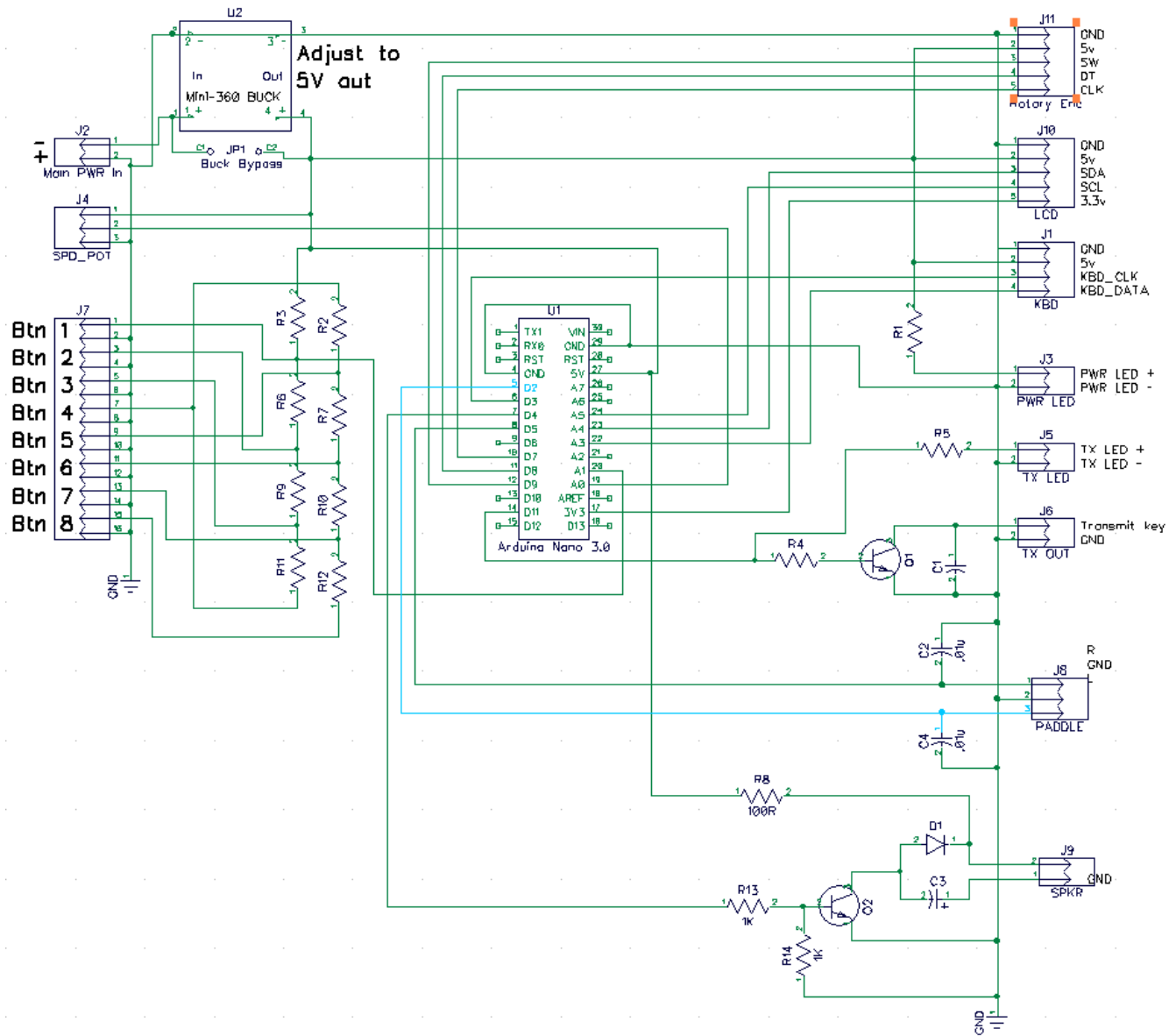











# 1.1 Schematic



## 2. Assembly Instructions

This section covers the construction of the nKeyer. It approaches assembly as a learning exercise for new builders, so that they can develop proficiency and self-confidence. The build is quite simple and if you follow the steps carefully, you should have a working board when you are done. Additional information and guides on techniques and tools can be found in the "Tools and Parts ID Guide" at: [www.renard-plus.com/files/Tools\\_and\\_Parts\\_ID\\_Guide.pdf](http://www.renard-plus.com/files/Tools_and_Parts_ID_Guide.pdf)

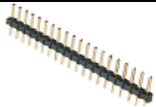
### 2.1 nKeyer board BOM/Parts List

Picture	Designators	Description	Qty	Note
	R1, R5	470 ohm resistor ¼ watt	2	
	R2, R4, R6, R7, R9-R14	1.0k ohm resistor ¼ watt	10	
	R3	10k ohm resistor ¼ watt	1	
	R8	100 ohm resistor ¼ watt	1	
	C1, C2, C4	.01uf (10nf) 50v monolithic ceramic cap	3	
	C3 Optional for DC blocking on the audio out.	Jumper wire (or 1uf - 220uf electrolytic or tantalum cap)	1	Typically not used - jumper across
	C5	220uf 16v electrolytic	1	
	D1	1N4148 diode	1	
	U1 (opt but recommended)	1x15 pin 2.54 pin spacing female header	2	Allows the Nano to be removed replaced
	U1	Arduino Nano 3.0 16MHz, 5V, ATMEGA328P	1	
	U2 (opt for >5v input)	Mini "360" Buck regulator (adjust to 5v output)	1	If your input is 5V, this can be left out by placing a jumper across JP1 "Buck bypass"
	Q1, Q2	2N2222a or 2N3904 NPN Transistor	1	
	J3-PWR LED, J5-TX LED	LED Standard 5mm (any color)	2	Place header pins if LED will be mounted on the enclosure.
	J1-1x4, J2-1x2, J4-1x3, J6-1x2, J8-1x3, J9-1x2, J10-1x5, J11-1x5	Single row headers – various	30 pins	Cut to appropriate # of pins for the location
	J7 Buttons 2x8	2x8 dual row header	1	

## 2.2 Other Parts to Consider

The following are additional parts you may want to consider:

- Enclosure (example the 100x68x50 mm “clear plastic project box” for under \$3 works well)
- 5V (no buck) or 7V-24V power supply with buck installed (9 volt battery works)
- A paddle key to enter Morse code
- 8 ohm speaker to hear the Morse tones
- 1601 LCD with Serial (I2C / SPI) interface
- Arduino Rotary Encoder module or 10K potentiometer for the Morse speed setting
- PS/2 or USB keyboard



The nKeyer is quite flexible and provides a wide range of options to try. The code for the board has an extensive set of compiled features, most that the nKeyer will support.

## 2.3 nKeyer Parts Assembly

This is a fairly simple device to assemble and test at a basic level. It is easiest if you follow these instructions, checking off steps as they are performed. This will lead you through the assembly installing components generally from shortest/smallest to tallest.

### 2.3.1 First Things First

1. Begin by inspecting the PCB to look for any defects such as cracks or breaks. The holes on the board should be open on both sides.

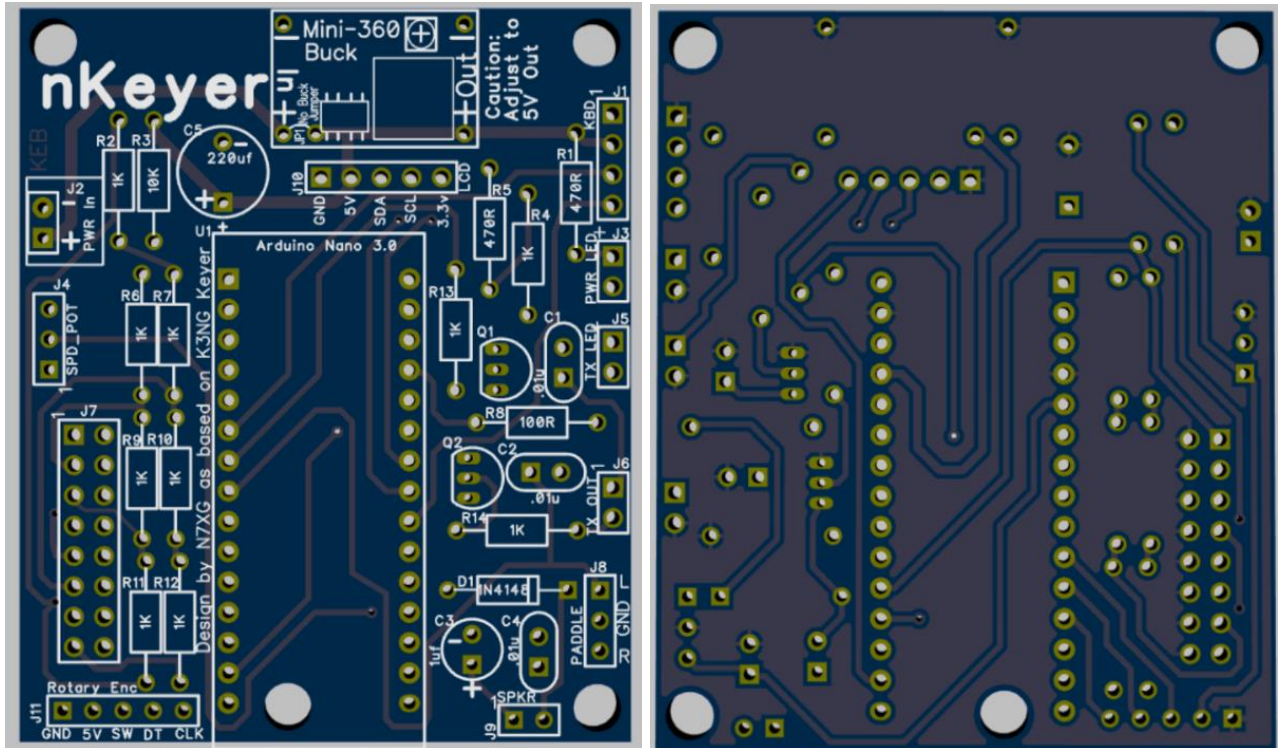

2. Next inspect and sort out the various parts for the board. Make sure you understand which parts are which, and things like resistor codes and component orientation. A Google search will yield a plethora of information including resource sites like Wikipedia.
3. Follow the assembly guide as follows in the next section.



## 2.4 Assembly Guide

Generally, the following component assembly order is grouped from shortest to tallest parts to make assembly easier. Special instructions for component orientation should be listed if a component has any. Don't stress it- we try to make this as easy as possible!

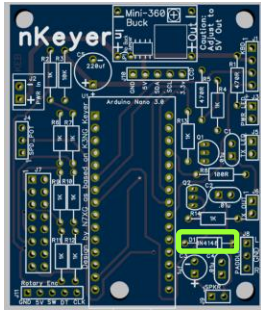
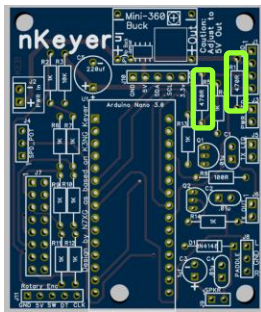
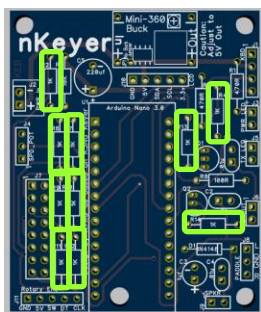
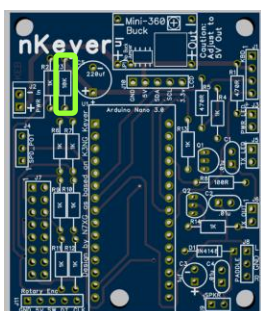
### 2.4.1 Install Parts

Step	Instructions	nKeyer
1 <input type="checkbox"/>	<p>Install the 1N4148 at location D1. Solder and clip leads.</p> <p><i>Note: The diode is polarized and must be installed with the proper orientation. The end with the band (cathode) goes towards the right side of the board as shown and as indicated on the board silkscreen.</i></p> 	
2 <input type="checkbox"/>	<p>Install the two 470 ohm (yellow-violet-brown) resistor at location R1 and R5. Solder and clip leads.</p> <p><i>Note: Resistors do not have a specific orientation.</i></p>	
3 <input type="checkbox"/>	<p>Install the ten 1K (brown-black-red) resistors at location R2, R4, R6, R7, R9-R14. Solder and clip leads.</p>	
4 <input type="checkbox"/>	<p>Install the 10K (brown-black-orange) resistor at location R3. Solder and clip leads.</p>	

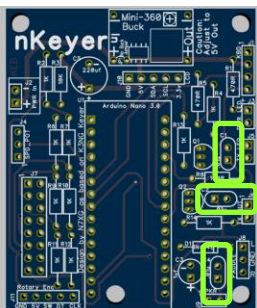
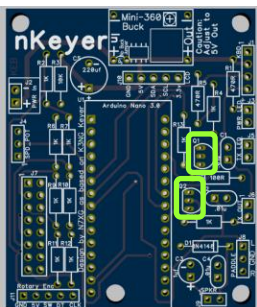

Step	Instructions	nKeyer
5 <input type="checkbox"/>	<p>Install the 100 ohm (brown-black-brown) resistor at location R8. Solder and clip leads.</p>	
6 <input type="checkbox"/>	<p>Install a jumper wire at location C3. Solder and clip leads.</p> <p><i>Note: a clipped resistor lead can be used as a jumper wire. Alternatively a 1uf up to 220uf electrolytic or tantalum cap can be used (Note polarity!!) however, audio volume may be inversely impacted. This option allows additional DC blocking out to an amplified audio device.</i></p>	
7 <input type="checkbox"/>	<p>Install the three 0.01uf Ceramic Capacitors at locations C1, C2 and C4. Solder and clip leads.</p> <p><i>Note: Bypass caps do NOT have a specific orientation. .01uf is also known as 10nf and can be marked 103 or 103K.</i></p>	
8 <input type="checkbox"/>	<p>Install two 2N2222 NPN Transistors (or equiv) at Q1 and Q2.</p> <p><i>Note: Transistors do have a polarity. The flat side of the transistor should match the flat side shown on the silkscreen. Flat side goes toward the left as shown. 2N3904 is a good substitute for a 2N2222a</i></p>	

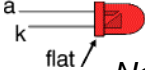
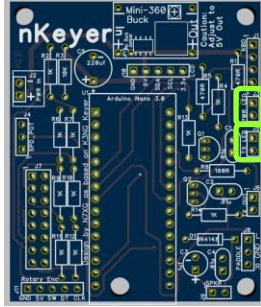
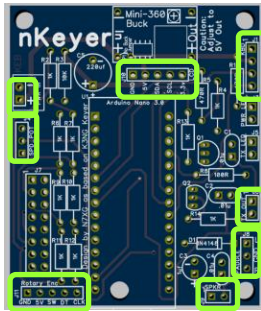
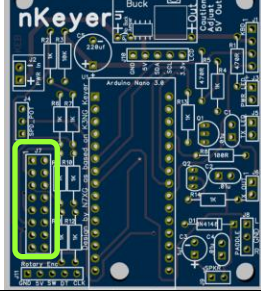
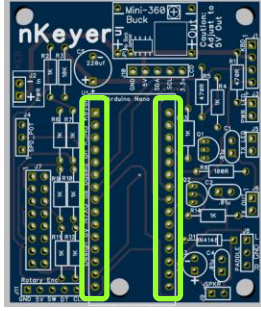
Step	Instructions	nKeyer
9 <input type="checkbox"/>	<p>For the power and transmit key indicators, either install two 1x2 male headers at J3 and J5 (for remote case mounted LEDs) or the install the 2 LED's at those locations. Solder and clip leads (if applicable).</p>   <p><i>Note: LEDs have a specific orientation. The flat side of the LED is negative (often the short lead) and goes toward the bottom of the board. The longer lead (opposite side of the LED from the flat spot) goes into the hole marked + toward the top of the board (as shown and as indicated on the silkscreen).</i></p>	
10 <input type="checkbox"/>	<p>Install the male header pins into the remaining locations J1 (KBD 1x4), J2 (PWR 1x2), J4 (POT 1x3), J6 (TX Out 1x2), J8 (Paddle 1x3), J9 (SPKR 1x2), J10 (LCD 1x5) and J11 (Encoder 1x5). Solder.</p> <p><i>Note: Two of the terminal block should be mated together before they are install at locations DC IN and AC IN. <b>The terminal blocks should be oriented facing outward.</b></i></p>	
11 <input type="checkbox"/>	<p>Install the 2x8 male header at J7. Solder</p>	
12 <input type="checkbox"/>	<p>Install the two 2.54 1x15 <u>FEMALE</u> headers at U1.</p> <p><i>Note: Optional but highly recommended so the Nano can be swapped if needed. If you do NOT install the headers here, do NOT install the Nano module yet- we will need to set/test the power first.</i></p>	

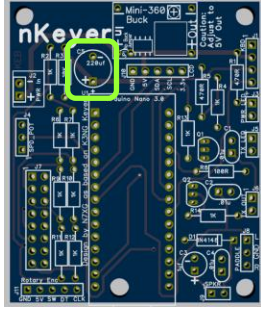
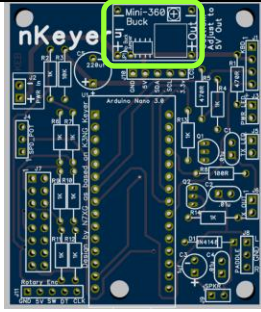
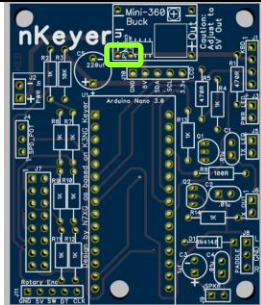
Step	Instructions	nKeyer
13 <input type="checkbox"/>	<p>Install the 220uf 16V electrolytic capacitor at location C5. Solder and clip leads.</p> <p><i>Note: Be sure that the (+) lead is installed in the hole marked with a “+” symbol. The (+) lead is usually longer than the (-) lead, and the (-) lead is usually identified by a black or white stripe on the capacitor.</i></p>	
14a <input type="checkbox"/>  -OR-	<p>If your input voltage is 7-24v (like a 9v battery), install the Mini-360 buck converter at indicated buck location. Solder.</p> <p><i>Note: The buck converter has a specific orientation and should match the silkscreen diagram. It can be mounted using either single male header pins at the four corners, OR with scrap wires such as the trimmings from the resistors, or with other wire. Please note that you will need to set the buck to output 5v during test so be sure the Nano is NOT installed before you set it to 5v!!</i></p>	
14b <input type="checkbox"/>	<p>If your input voltage will be clean 5v DC, then you can omit the buck converter and just place a jumper wire across JP1.</p>	

### 2.4.2 Setting the BUCK

Please follow this if you are using higher input voltage than 5V and have installed to optional buck converter. BEFORE installing the Arduino Nano board onto the nKeyer, the buck converter must be set for 5v output. This is accomplished by applying the supply voltage (7v - 23v) to J2 “PWR In” and measuring the buck output pins with a multimeter or volt meter, then adjusting the small potentiometer on the buck board until the voltage measures 5v.

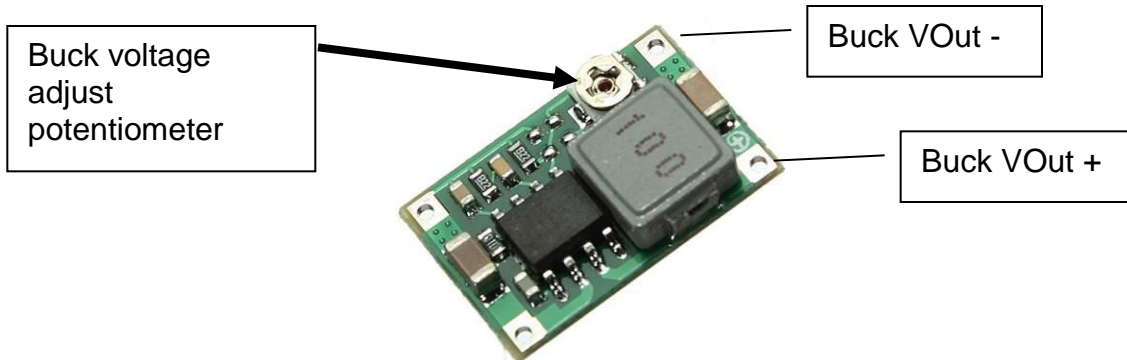

### 2.4.3 Installation final assembly

15 <input type="checkbox"/>	<p>Install the Nano board into the female headers installed at Step 12.</p> <p>Note the Arduino Nano has a specific orientation. The USB connector on it should be positioned toward the bottom as shown here</p>	
-----------------------------	---	--

## 2.5 Programming

Please refer to the firmware upload instructions here:

<https://nanokeyer.files.wordpress.com/2012/01/nanokeyer-firmware-upload-guide-21.pdf>

You will need to set the compile options in the K3NG Arduino Code from the Nano Keyer to match the options you are implementing on your board. The main setting is to set the “Nano Keyer Rev D” option. There are quite a few interesting options in the code, however, code space in the Nano is limited so you will need to pick and choose what you need.

## 2.6 Test

Apply power. If you implemented the display, you should get a title and a “hello” tone from the nKeyer audio out or speaker. Attach your paddle and verify you get the “dits” and “dahs” that you expect. Try out other features that you may have enable in the code, like Winkey, or memories.

**That completes the construction of the nKeyer board!**

### 3. Connectors / Options

The nKeyer was designed to be very flexible, allowing you to decide what you do or do NOT wish to hook to it. As such there are many options for connections to use. Loosely, these can be classified as Needed, Recommended, and Optional.

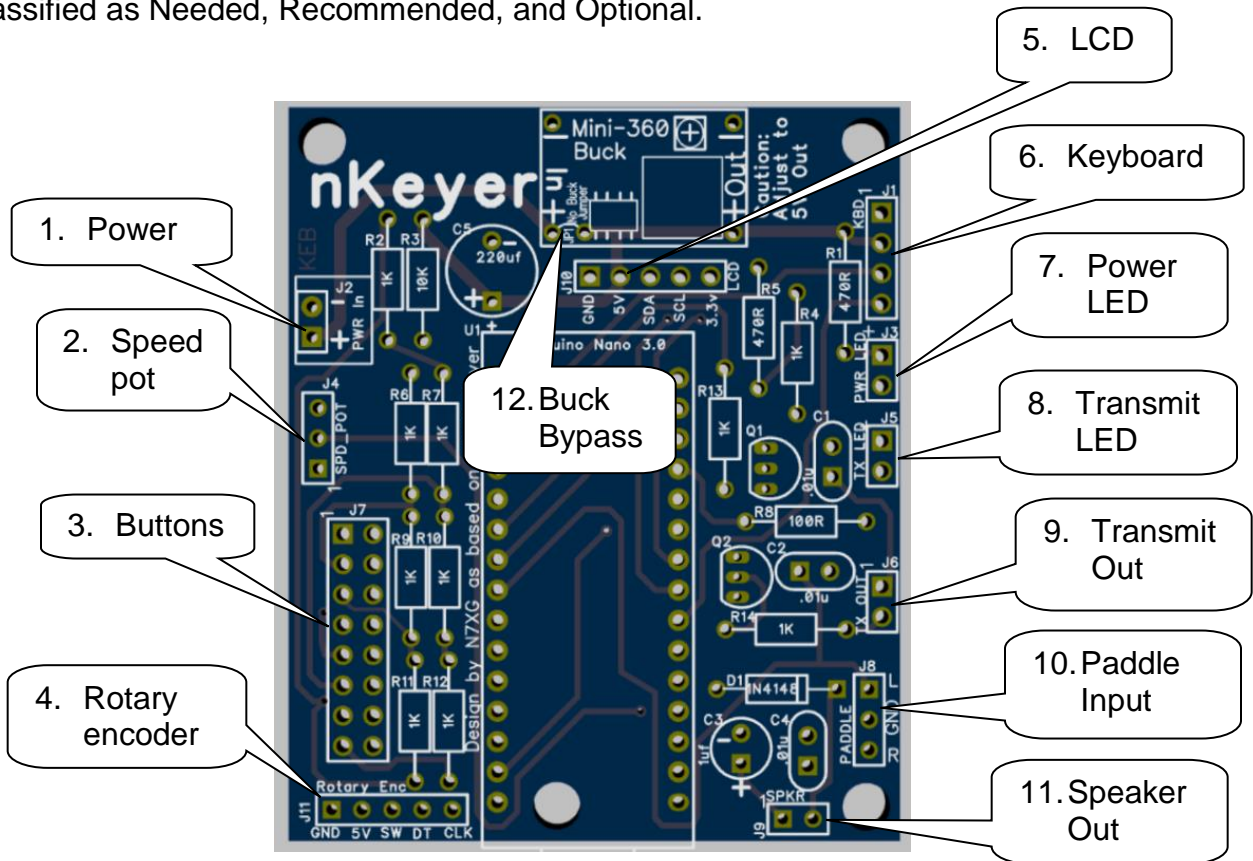

1. Power in (J2: PWR IN Pinout = “+ -”) – 5V (with no buck jumper installed) or 7-23v in with the Mini-360 buck installed. **NEEDED**
2. Speed Pot (J4: SPD\_POT Pinout = 3 pot pins) – connect to a 10K potentiometer to adjust the CW speed. Requires the code to be set for the speed pot option. Use this OR the rotary encoder. **OPTIONAL**
3. Buttons (J7) – Up to 10 function buttons (determined by the code settings). A typical configuration requires at least two buttons to be used. Button 1 connects to the top most two pins (horizontally across from each other), and button two connects to the two pins next down. **Minimum TWO RECOMMENDED / NEEDED**
4. Rotary Encoder (J11: Rotary Enc Pinout = “GND, 5V, SW, DT, CLK”) – The code supports the connection of an inexpensive rotary encoder used with Arduino projects to control CW speed and potentially other functions. This style of encoder can be found on Ebay for \$1 or less. Search for “Arduino Rotary Encoder”. This connector is designed to connect straight to an Arduino encoder as pictured. **RECOMMENDED**



5. LCD (J10: LCD Pinout = "GND, 5V, SDA, SCL, 3.3v") – The board will drive a Serial LCD character display. Most display run on 5v and will hook straight to the first 4 pins – HOWEVER- if the display you have needs 3.3v, that is also provided on the connector. The code is designed specifically for a "Serial 1602 LCD" that can be found on ebay for around \$2. **RECOMMENDED**

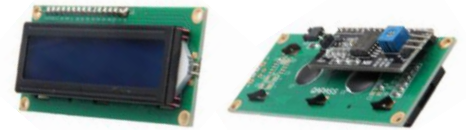

6. Keyboard (J1: KBD Pinout = "GND, 5V, KBD-CLK, KDB-DATA"). In theory, the code supports attaching a P/S2 or USB keyboard. This is an untested option as of publication of this document. **OPTIONAL**
7. LED Power (J3: PWR LED Pinout = "LED+, LED-")– This is a spot to directly hook an LED to indicate the power is on. There is a limiting resistor that keeps the voltage/current within range of modern 2.7 - 3V LEDs. **RECOMMENDED**
8. Transmit LED (J5: TX LED Pinout = "LED+, LED-")– This attaches to an LED to indicate when the Transmit Out (TX Out) is active. **RECOMMENDED**
9. Transmit Out (J6: TX OUT Pinout = "TX+, TX-") – This connection is used to key up your transmitter to send out code via the speaker connection. **RECOMMENDED**
10. Paddle Input – (J8: PADDLE Pinout = "L, GND, R") This connector is used to connect to your Paddles to have the nKeyer send out morse tones. One pin is the "Dit", one is the "Dah" and the middle pin is ground to the paddle. **NEEDED**
11. Speaker Out (J9: SPKR Pinout = "Spkr+, Spkr-") – This connection is to either hook directly to a speaker, or to the microphone input on your transmitter to allow the nKeyer to send out morse. **NEEDED**
12. Buck Bypass (JP1: No Buck Jumper) – If you will be using a clean 5V regulated input on J2 PWR IN (or will power off the USB connection on the Nano), you do not need to install the Mini-360 Buck Converter, but instead can jumper JP1. This will connect J2 straight to the 5V power bus on the board. If you attach any power higher than 5V in this configuration, it WILL blow up the board. Either a MINI-360 or a jumper is **NEEDED**